

**BA418CF-F**  
**FOUNDATION™ fieldbus**  
**Intrinsically safe**  
**Panel mounting**  
**Fieldbus Indicator**

Issue: 5

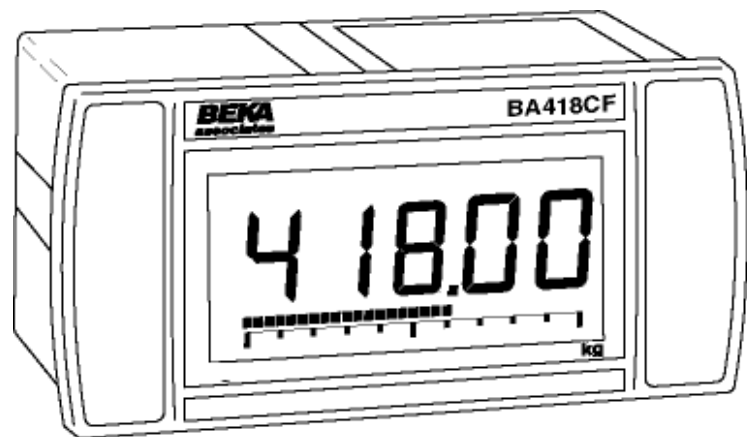

## CONTENTS

### 1. Description

- 1.1 Documentation

### 2. Intrinsic Safety Certification

- 2.1 ATEX certificate
- 2.2 Zones, gas groups and T rating
- 2.3 Fieldbus connection
- 2.4 Certification label Information

### 3. System Design for Hazardous Area

- 3.1 FISCO Systems
- 3.2 Non-FISCO Systems

### 4. Installation

- 4.1 Location
- 4.2 Installation procedure
- 4.3 EMC

### 5. Maintenance

- 5.1 Fault finding during commissioning
- 5.2 Fault finding after commissioning
- 5.3 Servicing
- 5.4 Routine maintenance
- 5.5 Guarantee
- 5.6 Customer comments

### 6. Accessories

- 6.1 Scale marking
- 6.2 Tag number
- 6.3 Fieldbus Interface Guide

### 7. Index

#### Appendix 1

FM Approval for use in the USA and  
cFM Approval for use in Canada.

#### Appendix 2

IECEx certification

The BA418CF-F is CE marked to show compliance with the European Explosive Atmospheres Directive 94/9/EC and the European EMC Directive 2004/108/EC

## 1. DESCRIPTION

The BA418CF-F Fieldbus Indicator is an intrinsically safe, FOUNDATION™ fieldbus instrument that can display one fieldbus process variable on a five digit LCD and 31 segment analogue bargraph. The instrument is bus powered so no additional power supply is required.

Communication Protocol	Fieldbus Function Block
FOUNDATION™ fieldbus	Input Selector (1 x IS)

The Device Description files may be downloaded from The Fieldbus Foundation or the BEKA associates web site.

Housed in a robust 72 x 144 panel mounting DIN enclosure, the BA418CF-F fieldbus indicator has an IP66 front panel and is supplied with a gasket to seal the joint between the instrument and the panel.

The instrument is intrinsically safe and has been certified by European Notified Body Intertek Testing and Certification Ltd (ITS) to the ATEX Directive 94/9/EC for use in explosive gas atmospheres.

The BA418CF-F also has intrinsic safety and nonincendive FM and cFM Approval allowing installation in the USA and Canada – see Appendix 1.

For international applications the BA418CF-F fieldbus indicator has IECEx intrinsic safety approval – see Appendix 2.

The instrument's communication protocol is shown on the rear of the instrument. The '-F' order code suffix also indicates the protocol but is not shown on the instrument certification label.

### 1.1 Documentation

This instruction manual describes ATEX system design and installation of the BA418CF-F Fieldbus Indicator. For commissioning information please refer to:

FOUNDATION™ fieldbus  
Fieldbus Interface Guide  
for  
Fieldbus Displays and  
Fieldbus Indicators

which can be requested via the BEKA web site [www.beka.co.uk](http://www.beka.co.uk)

System design information for FM, cFM and IECEx is shown in separate appendices to this manual.

## 2. INTRINSIC SAFETY CERTIFICATION

### 2.1 ATEX certificate

The BA418CF-F has been issued with an EC-Type Examination Certificate by Notified Body Intertek Testing and Certification Ltd (ITS) confirming compliance with the European ATEX Directive 94/9/EC for Group II, Category 1G, gas atmospheres, Ga Ex ia IIC T4. The instrument bears the Community Mark and, subject to local codes of practice, may be installed in any of the European Economic Area (EEA) member countries. ATEX certificates are also acceptable for installations in Switzerland.

This manual describes ATEX installations in explosive gas atmospheres that conform with EN 60079:Part14 Electrical Installation in Hazardous Areas. When designing systems for installation outside the UK, the local Code of Practice should be consulted.

### 2.2 Zones, gas groups and T rating

The BA418CF-F has been issued with EC Type Examination certificate ITS06ATEX25314/2X confirming that it complies with the requirements for Group II Category 1G Ga Ex ia IIC T4 (Tamb –40 to 70°C) specified in the ATEX Directive. When connected to a suitable certified system the BA418CF-F may be installed in:

Zone 0	explosive gas air mixture continuously present. <b>Note:</b> Special conditions for safe use apply see section 4.1
Zone 1	explosive gas air mixture likely to occur in normal operation.
Zone 2	explosive gas air mixture not likely to occur, and if it does will only exist for a short time.

Be used with gases in groups:

Group A	propane
Group B	ethylene
Group C	hydrogen

Having a temperature classification of:

T1	450°C
T2	300°C
T3	200°C
T4	135°C

At an ambient temperature between –40 and +70°C.

**Note:** the guaranteed operating temperature range of the Fieldbus Indicator is –20 to +70°C.

### 2.3 Fieldbus connection

The BA418CF-F Indicator is powered and communicates via the fieldbus, which is connected to terminals 1 and 2. These are non-polarised, comply with the Fieldbus Intrinsically Safe Concept (FISCO) defined in EN 60079 Part 27 and have separate entity parameters shown below:

	FISCO	Entity
U <sub>i</sub>	= 17.5V dc	22.0V dc
I <sub>i</sub>	= 380mA dc	250mA dc
P <sub>i</sub>	= 5.32W	1.2W

The maximum equivalent capacitance and inductance at terminals 1 & 2 is:

C <sub>i</sub>	= 0
L <sub>i</sub>	= 8μH

Fig 1 shows a typical fieldbus segment. To comply with FISCO requirements, the power supply, terminators, field devices and the interconnecting cables must conform with EN 60079 part 27.

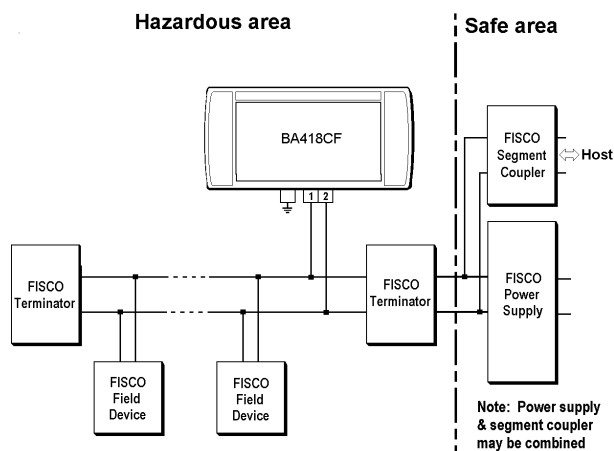
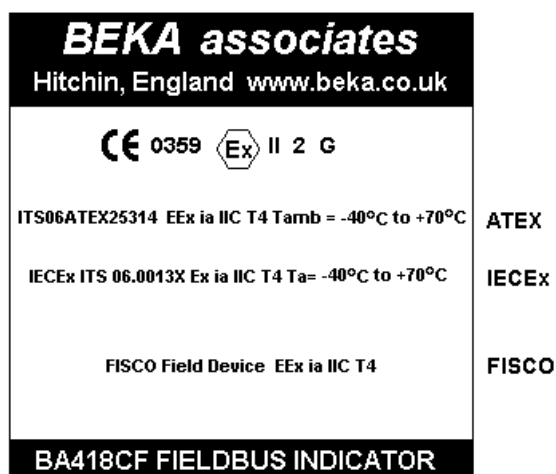

Fig 1 FISCO fieldbus system

### 2.4 Certification Label Information

The certification information label is fitted to the top outer surface of the enclosure. It shows details of the ATEX certification and a statement that the instrument is a FISCO Field Device, plus BEKA associates name and location. IECEx approval information is also included. The label may also contain non-European certification information. The instrument serial number and year of manufacture are shown on the rear panel.

The instrument serial number is shown on the rear of the instrument adjacent to the terminals.



### 3.2 Non-FISCO Systems

For non-FISCO applications the BA418CF-F Fieldbus Indicator has a higher voltage entity intrinsic safety input parameter allowing connection to a wide range of fieldbus segments.

The BA418CF-F Fieldbus Indicator may be connected to any intrinsically safe segment providing:

The device powering the fieldbus segment is ATEX certified and has output parameters equal to or less than:

U <sub>o</sub>	= 22V dc
I <sub>o</sub>	= 250mA dc
P <sub>o</sub>	= 1.2W

The segment can provide an additional 13mA to power the Fieldbus Indicator.

**Note:** The equivalent capacitance C<sub>i</sub> of the BA418CF-F Fieldbus Indicator is zero and the equivalent inductance is insignificant. Therefore these BA414DF parameters do not need to be considered.

## 3. SYSTEM DESIGN FOR HAZARDOUS AREAS

### 3.1 FISCO Systems

The BA418CF-F may be connected to any ATEX certified FISCO compliant fieldbus segment, providing the segment can supply the additional 13mA required to power the instrument.

## 4. INSTALLATION

### 4.1 Location

The BA418CF-F is housed in a robust aluminium enclosure with a toughened glass window mounted in a Noryl bezel. The front of the instrument provides IP66 protection and a gasket seals the joint between the instrument enclosure and the panel. The instrument may be installed in any panel providing the environmental limits shown in the specification are not exceeded.

Fig 2 shows the overall dimensions of the BA418CF-F and the panel cut-out. To achieve an IP66 seal between the instrument enclosure and the panel, the smaller cut-out must be used and the instrument secured with four panel mounting clips.

### CAUTION

#### Installation in Zone 0

**When installed in a Zone 0 potentially explosive atmosphere requiring apparatus of Category 1G, the indicator shall be installed such that even in the event of rare incidents, an ignition source due to impact or friction between the aluminium enclosure at the rear of the instrument mounting panel and iron/steel is excluded.**

The BA418CF-F liquid crystal display has maximum contrast when viewed from directly ahead and slightly below the centre line of the instrument.

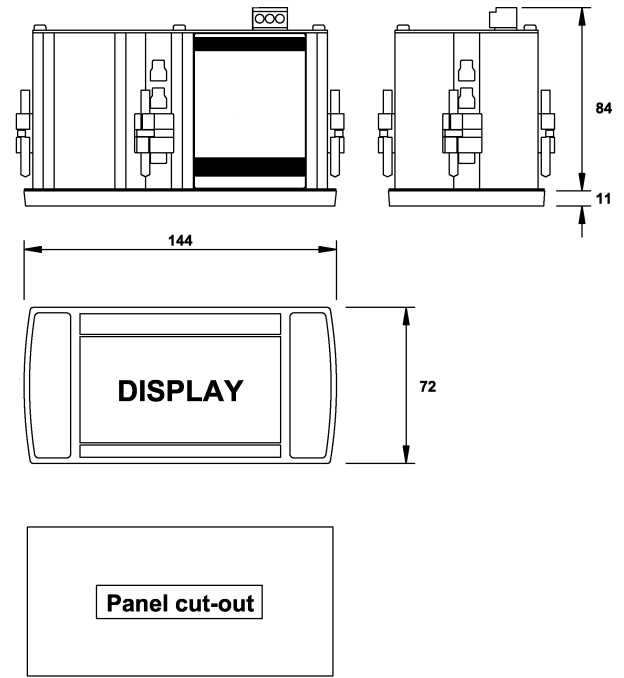

#### Cut-out Dimensions

##### DIN 43 700

138.0 +1.0/-0.0 x 68.0 +0.7/-0.0

**To achieve an IP66 seal  
between instrument enclosure  
and panel**

136.0 +0.5/-0.0 x 66.2 +0.5/0.0

Fig 2 BA418CF-F dimensions

## 4.2 Installation Procedure

- a. Insert the BA418CF-F into the instrument panel cut-out from the front of the panel.
- b. Fix panel mounting clips to opposite sides of the instrument and tighten until the instrument is secure. Four clips are required to achieve an IP66 seal between the instrument enclosure and the panel.
- c. Connect the panel wiring to the rear terminal block as shown in Fig 3. To simplify installation, the terminals are removable so that panel wiring can be completed before the instrument is installed.

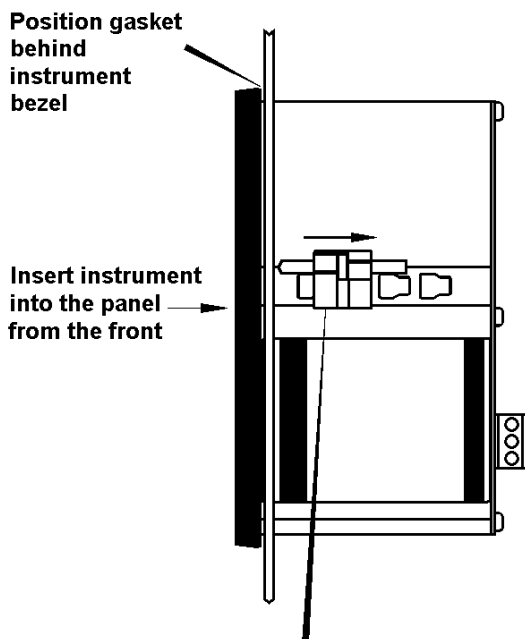

Slide panel mounting clip into the slotted rail on the side of the enclosure. Four clips are required to achieve an IP66 seal between instrument and panel.

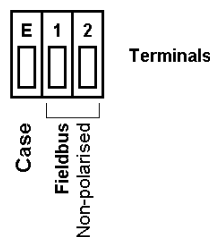

Fig 3 Installation and terminal connections

## 4.3 EMC

The BA418CF-F complies with the requirements of the European EMC Directive 89/336/EEC. For specified immunity, all wiring should be in screened twisted pairs with the screens earthed at one point in the safe area.

## 5. MAINTENANCE

### 5.1 Fault finding during commissioning

If a BA418CF-F fails to function during commissioning the following procedure should be followed:

Symptom	Cause	Check:
No Display	Instrument not correctly connected or powered.	9 to 22V between terminals 1 & 2.
Display shows '9.9.9.9.9' with all decimal points flashing; all bargraph segments activated and bargraph scale flashing.	Value over-range	Variable source  Decimal point configuration.
Display shows '-9.9.9.9.9' with all decimal points flashing; no bargraph segments activated and bargraph scale flashing.	Value under-range	Variable source  Decimal point configuration
Display alternates between value and the word 'bAd'. Bargraph flashes.	Status of fieldbus variable has a quality of 'BAD' or a fault state is active.  Display has not yet received data.	Variable source  Fieldbus configuration.
Bargraph scale flashes.	Variable is outside the limits defined for the bargraph.	Bargraph configuration.
All display segments activated.	Display is initialising.	This is normal operation, after a few seconds the firmware version will be displayed prior to entering the operational mode.

### 5.2 Fault finding after commissioning

#### ENSURE PLANT SAFETY BEFORE STARTING MAINTENANCE

**Live maintenance is permitted on intrinsically safe equipment installed in a hazardous area, but only certified test equipment should be used unless a gas clearance certificate is available.**

If a BA418CF-F fails after it has been functioning correctly, the table shown in section 5.1 may help to identify the cause of the failure.

If this procedure does not reveal the cause of the fault, it is recommended that the instrument is replaced.

### 5.3 Servicing

We recommend that faulty BA418CF-F Fieldbus Indicators be returned to BEKA associates or to our local agent for repair.

### 5.4 Routine maintenance

The mechanical and electrical condition of the instrument should be regularly checked. Initially annual inspections are recommended, but the inspection frequency should be adjusted to suit the environmental conditions.

### 5.5 Guarantee

Instruments which fail within the guarantee period should be returned to BEKA associates or our local agent. It is helpful if a brief description of the fault symptoms is provided.

### 5.6 Customer comments

BEKA associates is always pleased to receive comments from customers about our products and services. All communications are acknowledged and whenever possible, suggestions are implemented.

## 6. ACCESSORIES

### 6.1 Scale marking

BA418CF-F indicators are fitted with a blank escutcheon around the liquid crystal display. If specified when the instrument is ordered, this can be supplied printed with units of measurement and a scale for the horizontal bargraph.

### 6.2 Tag number

The BA418CF-F can be supplied with a thermally printed tag number on the rear panel adjacent to the terminals.

### 6.3 Fieldbus Interface Guide

The *FOUNDATION™ fieldbus Interface Guide for Fieldbus Displays & Fieldbus Indicators* contains commissioning information for the BA418CF-F. A copy may be requested from the BEKA sales office or from the BEKA web site at [www.beka.co.uk](http://www.beka.co.uk)



## 7. INDEX

Subject	Section	Subject	Section
ATEX Directive	2.1	Notified Body	1; 2.1
Codes	2.2		
Certification		Servicing	5.3
ATEX	2.1	Scale marking	6.1
CFM Canada	1.0; Appendix 1	Tag number	6.2
EC-Type Examination	2.1	T rating	2.2
FM USA	Appendix 1	Terminal numbers	Appendices 1 & 2. Fig 3
IECEX	Appendix 2		
Label ATEX	2.4	Units of measurement	6.1
Divisions	Appendix 1	Zones	2.2
Documentation	1.1		Appendices 1 & 2.
EMC	4.3		
Fault finding			
During commissioning	5.1		
After commissioning	5.2		
Fieldbus			
Connection	2.3; Fig 3		
Foundation	1; 3		
Guide	1.1; 6.3		
Firmware version number	5.1		
FISCO	2.3; 2.4; 3.1		
FM Approval	Appendix 1		
Function Blocks	1.		
Gas groups	2.2		
Guarantee	5.5		
IECEX Certification	Appendix 2		
Installation	4.		
Intrinsic safety	2.0; Appendices 1 & 2.		
Location	4.1 Appendices 1 & 2.		
Maintenance	5.		
Routine	5.4		

## APPENDIX 1

### FM approval for use in the USA and cFM Approval for use in Canada

#### A1.0 Factory Mutual Approval

For installations in the USA and Canada the BA418CF-F has FM and CFM intrinsic safety and nonincendive approvals, project identification 3027031 and 3027031C. Copies of the Certificates of Compliance are available from BEKA associates sales office and [www.beka.co.uk](http://www.beka.co.uk).

#### A1.1 Intrinsic safety approval

The BA418CF-F is approved to FM Class 3610 intrinsic safety standard for use in hazardous (classified) locations. Installations must comply with BEKA associates Control Drawing CI410-12, which is attached to this Appendix, ANSI/ISA RP12.06.01 'Installation of Intrinsically Safe Systems for Hazardous (Classified) Locations' and with the National Electrical Code ANSI/NFPA70.

Canadian installations must comply with the Canadian Electrical Code C22.2 and with BEKA associates Control Drawing CI410-12 which is attached to this Appendix.

The BA418CF-F has a T4 rating at ambient temperatures up to +70°C and may be used with the following gases:

Intrinsic Safety	
Division 1 or 2	
Class I	Group A & B Group C Group D
Zone 0, 1 or 2	
Class 1	Group IIC Group IIB Group IIA

The FM and CFM entity parameters are identical to the ATEX parameters and, like the ATEX certification, confirm that the BA418CF-F complies with the FISCO Field Device requirements specified in IEC60079-27. The intrinsically safe system shown in Fig 1 of this manual may therefore be used for installations in the USA and Canada, providing the fieldbus power supply, terminators, Zener barriers and galvanic isolators are FM Approved for US installations and CFM or CSA Approved for Canadian installations. All installations must comply with BEKA associates Control Drawing CI410-12.

FM and CFM Approval also allows the BA418CF-F to be connected to non-FISCO systems using the entity concept – see section 3.2 of this manual.

#### A1.2 Nonincendive approval

The BA418CF-F is also Class 3611 nonincendive approved by Factory Mutual allowing it to be installed in Division 2 hazardous (classified) locations without the need for Zener barriers or galvanic isolators. US installations must comply with the BEKA associates Control Drawing CI410-13, which is attached to this Appendix, and with the National Electrical Code ANSI/NFPA70.

Canadian nonincendive installations must comply with the Canadian Electrical Code C22.2 and with BEKA associates Control Drawing CI410-13 which is attached to this Appendix.

The FM and CFM Nonincendive Approvals also allow the BA418CF-F fieldbus indicator to be connected to any appropriately certified FNICO compliant fieldbus segment.

The BA418CF-F has a T4 rating at ambient temperatures up to +70°C and may be used with the following gases:

Nonincendive	
Division 2	
Class I	Group A & B Group C Group D
Zone 2	
Class I	Group IIC Group IIB Group IIA

Iss.	Date	Modification	Ckd.	Appd.	<p><b>HAZARDOUS (CLASSIFIED) LOCATION</b></p> <p><b>BA414DF LOCATIONS:</b>                  Class I, Division 1, Groups A, B,C, D                  Class II, Division 1, Groups E, F &amp; G                  Class III                  Class I, Zone 0, Group IIC</p> <p><b>BA418CF LOCATIONS:</b>                  Class I, Division 1, Groups A, B,C, D                  Class I, Zone 0, Group IIC</p>	<p><b>UNCLASSIFIED LOCATION</b></p>																
Iss.	Date	Modification	Ckd.	Appd.																		
<p><b>BEKA associates</b>                  Hitchin England                  company confidential, copyright reserved.</p>					<p><b>BA414DF and BA418CF</b></p> <p>Terminals 1 &amp; 2                  These terminals comply with the Intrinsically Safe Concept (FISCO) defined by IEC 60079-27</p> <p> <math>U_i = 17.5V</math>      <math>U_o = 0</math>  <math>I_i = 380mA</math> dc    <math>I_o = 0</math>  <math>P_i = 5.32W</math>      <math>P_o = 0</math>  <math>C_i = 0</math>  <math>L_i = 8\mu H</math> </p> <p>and have the following Entity Parameters</p> <p> <math>U_i = 22Vdc</math>      <math>U_o = 0</math>  <math>I_i = 250mA</math>      <math>I_o = 0</math>  <math>P_i = 1.2W</math>      <math>P_o = 0</math> </p>																	
<p>Notes:</p>					<p>*****                  Note:                  No modification to be made without reference/approval from FM Approvals and BEKA Associates Design Department.                  *****</p>																	
<ol style="list-style-type: none"> <li>The associated intrinsically safe barriers and fieldbus power supply must be FM approved and the manufacturers' installation drawings shall be followed when installing this equipment.                      For installations in Canada the associated intrinsically safe barriers and fieldbus power supply must be CFM or CSA approved and the manufacturers' installation drawings shall be followed when installing the equipment.</li> <li>The unclassified location equipment connected to the associated intrinsically safe barriers and fieldbus power supply shall not use or generate more than 250V rms or 250V dc.</li> <li>Installation shall be in accordance with ANSI/ISA RP 12.06.01 "Installation of Intrinsically Safe Systems for Hazardous (Classified) Locations" and the National Electrical Code ANSI/NFPA 70.                      Installations in Canada shall be in accordance with the Canadian Electrical Code C22.2</li> <li>Fieldbus power supply with FISCO compliant output (IEC6009-27) or galvanic isolator with entity parameters complying with the following requirements:</li> </ol>																						
Date	28.03 2006	Modification	First release	Iss.	1	<p>Title</p> <p>FM Approvals Control Drawing for Intrinsically Safe BA414DF &amp; BA418CF Fieldbus Indicators</p>	<table border="1"> <tr> <td>Drawn</td> <td>Checked</td> <td>Scale</td> </tr> <tr> <td>RC</td> <td></td> <td>NTS</td> </tr> <tr> <td colspan="3">Drawing No.</td> </tr> <tr> <td colspan="3">Sheet 1 of 3</td> </tr> <tr> <td colspan="3" style="text-align: center;">C1410-12</td> </tr> </table> <p>File: C1410-12s1.dwg 25.10.06</p>	Drawn	Checked	Scale	RC		NTS	Drawing No.			Sheet 1 of 3			C1410-12		
Drawn	Checked	Scale																				
RC		NTS																				
Drawing No.																						
Sheet 1 of 3																						
C1410-12																						

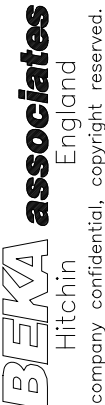
Iss.	Date	Modification	Ckd.	Appd.						
 <p><b>BEMA</b> Hitчин <b>associates</b> England company confidential, copyright reserved.</p>	Iss.	Date	Ckd.	Appd.						
	Modification	Date	Iss.	Appd.						
<p>5. To maintain IP66 protection between the BA418CF and the mounting panel:                  Four panel mounting clips should be used                  Minimum panel thickness should be              2mm (0.08inches) Steel                     3mm (0.12inches) Aluminium                  Outside panel finish should be smooth, free from particle inclusions, runs or build-up around cut-out.                  Panel cut-out should be                                  66.2 x 136.0mm -0.0 +0.5                     (2.60 x 5.35 inches -0.00 +0.02)                  Edges of panel cut-out should be deburred and clean                  Each panel mounting clip should be tightened to between:                          20 and 22cNm (1.77 to 1.95 inLb)</p> <p>6. When installed in a hazardous (classified) location the BA414DF Fieldbus Indicators shall be fitted with cable glands / conduit hubs selected from the following table                  Metallic glands and hubs must be grounded – see note 7.</p> <table border="1" data-bbox="478 795 1276 1209"> <thead> <tr> <th>Class</th> <th>Permitted gland or conduit hub</th> </tr> </thead> <tbody> <tr> <td>Class I</td> <td>Any metallic or plastic cable gland or conduit hub that provides the required environmental protection.</td> </tr> <tr> <td>Class II and III</td> <td><b>Crouse – Hinds Myler hubs</b> SSTG-1 STG-1 STAG-1 MHUB-1  <b>O-Z / Gedrey Hubs</b> CHMG-50DT  <b>REMKE hub</b> WH-1-G  <b>Killark Glands</b> CMCXAA050 MCR050 MCX050</td> </tr> </tbody> </table> <p>7. In addition to the supplied bonding plate, when 3 metallic glands or conduit hubs are fitted to a BA414DF Fieldbus Indictors, all metallic glands or conduit hubs must be connected together and grounded.</p> <p>8. <b>CAUTION:</b> The BA414DF and BA418CF Fieldbus Indicator enclosures are manufactured from conductive plastic per Article 250 of the National Electrical Code the enclosures shall be grounded using the 'E' terminal on the terminal block.</p> <p>9. The terminator on the Fieldbus must be FM or for Canadian installations CFM or CSA Approved.</p> <p>10. The BA414DF and BA418CF should be mounted where they are shielded from direct sunlight.</p> <p style="text-align: right;">cont:</p>	Class	Permitted gland or conduit hub	Class I	Any metallic or plastic cable gland or conduit hub that provides the required environmental protection.	Class II and III	<b>Crouse – Hinds Myler hubs</b> SSTG-1 STG-1 STAG-1 MHUB-1  <b>O-Z / Gedrey Hubs</b> CHMG-50DT  <b>REMKE hub</b> WH-1-G  <b>Killark Glands</b> CMCXAA050 MCR050 MCX050	Date 28.03 2006	Title	1	
Class	Permitted gland or conduit hub									
Class I	Any metallic or plastic cable gland or conduit hub that provides the required environmental protection.									
Class II and III	<b>Crouse – Hinds Myler hubs</b> SSTG-1 STG-1 STAG-1 MHUB-1  <b>O-Z / Gedrey Hubs</b> CHMG-50DT  <b>REMKE hub</b> WH-1-G  <b>Killark Glands</b> CMCXAA050 MCR050 MCX050									
<p>FM Approvals Control Drawing for Intrinsically Safe BA414DF &amp; BA418CF Fieldbus Indicators</p>										
	Drawn RC	Checked	Scale NTS	Drawing No. Sheet 2 <b>CI410-12</b>						
File: CI410-12s2.dwg 26.10.06										

Iss.									
Date	28.03 2006								
Modification	First release								
Ckd.									
Appd.									
									
Iss.	1								
<p><b>FISCO Rules</b></p> <p>The FISCO Concept allows the interconnection of intrinsically safe apparatus to associated apparatus not specifically examined in such combination. The criterion for such interconnection is that the voltage (Vmax), the current (Imax) and the power (Pmax) which intrinsically safe apparatus can receive and remain intrinsically safe, considering faults, must be equal or greater than the voltage (Uo, Voc or Vt), the current (Io, Isc or It) and the power (Po) which can be provided by the associated apparatus (supply unit). In addition the maximum unprotected residual capacitance (Ci) and inductance (Li) of each apparatus (other than terminators) connected to the Fieldbus must be less than or equal to 5nF and 10uH respectively.</p> <p>In each I.S. Fieldbus segment only one active source, normally the associated apparatus, is allowed to provide the necessary power for the Fieldbus system. The allowed voltage (Uo, Voc or Vt) of the associated apparatus used to supply the bus cable must be limited to the range 14Vdc to 24Vdc. All other equipment connected to the bus cable has to be passive, meaning that the apparatus is not allowed to provide energy to the system, except a leakage current of 50µA for each connected device. Separately powered equipment needs galvanic isolation to ensure the intrinsically safety Fieldbus circuit remains passive.</p> <p>The cable used to interconnect the devices needs to comply with the following parameters:          Loop resistance R': 15....150Ω/km          Inductance per unit length L':0.4....1mH/km</p> <p>Capacitance per unit length C': 80....200nF/km          C' = C' line/line+0.5 C' line/screen, if both lines are floating          or          C' = C' line/line + C'line/screen, if the screen is connected to one line.          Length of spur cable: max. 30m          Length of trunk cable: max. 1km          Length of splice: max = 1m          Terminators          At the end of each trunk cable an FM Approved line terminator with the following parameters is suitable:          R= 90....100Ω          C = 0 ....2.2µF</p> <p><b>System evaluation</b>          The number of passive devices like transmitters, actuators, connected to a single bus segment is not limited due to I.S. reasons. Furthermore, if the above rules are respected, the inductance and the capacitance of the cable need not be considered and will not impair the intrinsic safety of the installation.</p> <p><b>Notes.</b>          1. The intrinsic safety FISCO concept allows the interconnection of FM Approved Intrinsically Safe devices with FISCO parameters not specifically examined in combination as a system when:  <math>U_o</math> or <math>V_{oc}</math> or <math>V_t \leq V_{max}</math>, <math>I_o</math>, <math>I_{sc}</math> or <math>I_t \leq I_{max}</math>, <math>P_o \leq P_i</math>.          For Canadian installations the intrinsic safety FISCO concept allows the interconnection of CFM or CSA Approved Intrinsically Safe devices with FISCO parameters not specifically examined in combination as a system when:  <math>U_o</math> or <math>V_{oc}</math> or <math>V_t \leq V_{max}</math>, <math>I_o</math>, <math>I_{sc}</math> or <math>I_t \leq I_{max}</math>, <math>P_o \leq P_i</math>.</p>									
Title						Drawn	Checked	Scale	
FM Approvals Control Drawing for Intrinsically Safe BA414DF & BA418CF Fieldbus Indicators						RC		NTS	
						Drawing No.	CI410-12		
						Sheet 3			

Appd.	
Ckd.	
Modification	
Date	
Iss.	
Appd.	
Ckd.	
Modification	First release
Date	28.03 2006
Iss.	1

**HAZARDOUS (CLASSIFIED) LOCATION**

**BA414DF LOCATIONS:**

- Class I, Division 2, Groups A, B, C, D
- Class II, Division 2, Groups E, F & G
- Class III
- Class I, Zone 2, Groups IIC

**BA418CF LOCATIONS:**

- Class I, Division 2, Groups A, B, C, D
- Class I, Zone 2, Groups IIC

**BA414DF and BA418CF**  
Maximum input and output parameters

Terminals 1 & 2  
These terminals comply with The Fieldbus Nonincendive Concept (FNICO) defined by IEC60079-27  
(Typical current consumption 13mA)

V<sub>max</sub> = 32V dc  
NIFW V<sub>max</sub> = 17.5V (FNICO)  
C<sub>i</sub> = 0  
L<sub>i</sub> = 8μH

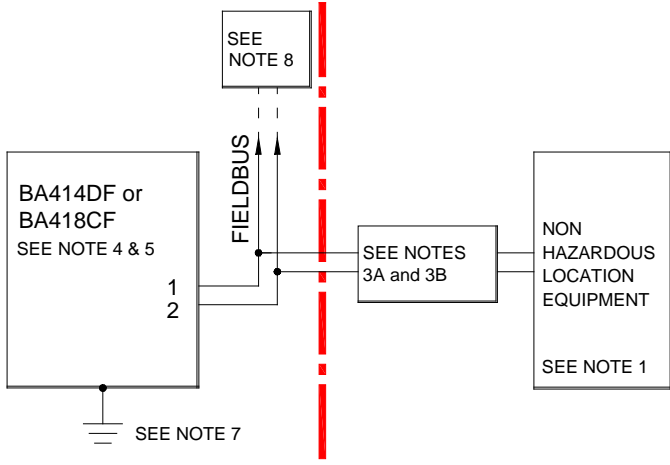

\*\*\*\*\*  
**Note:**  
 \*\*\*\*\*  
 No modification to be made  
 without reference/approval  
 from FM Approvals and  
 BEKA Associates Design  
 Department.  
 \*\*\*\*\*

**Notes:**

1. The unclassified location equipment connected to the associated nonincendive field wiring apparatus must not use or generate more than 250V rms or 250V dc.
2. Nonincendive field wiring installations shall be in accordance with the National Electrical Code ANSI/NFPA 70. The Nonincendive Field Wiring concept allows interconnection of Nonincendive Field Wiring Apparatus with Associated Nonincendive Field Wiring Apparatus using any of the wiring methods permitted for unclassified locations.  
Canadian installations shall be in accordance with the Canadian Electrical Code C22.2
- 3A. Linear power supply  
A linear fieldbus power supply shall be:  
 FM Approved Associated Nonincendive Field Wiring Apparatus installed in the unclassified location with parameters complying with the following requirements:  
 For Canadian Installations apparatus shall be CFM or CSA approved.  
 OR  
 FM Approved Nonincendive Field Wiring Apparatus installed in the classified location with parameters complying with the following requirements:  
 For Canadian Installations apparatus shall be CFM or CSA approved.  

V <sub>oc</sub>	equal to or less than	V <sub>max</sub>
L <sub>a</sub>	equal to or greater than	L <sub>cable</sub> + L <sub>i</sub>
C <sub>a</sub>	equal to or greater than	C <sub>cable</sub>

Cont.

Title  
 FM Approvals Control Drawing for Nonincendive  
 BA414DF & BA418CF Fieldbus Indicators

Drawn	RC	Checked	Scale
			NTS
Drawing No.		CI410-13	
Sheet 1 of 4			

Iss.	Date	Modification	Ckd.	Appd.																		
1	28.03 2006	First release	.	.																		
 <b>associates</b> England company confidential, copyright reserved.																						
Iss.	Date	Modification	Ckd.	Appd.																		
<p>3B. FNICO non-linear power supply                  A FNICO non-linear fieldbus power supply shall be:                  FM Approved Associated Nonincendive Field Wiring Apparatus installed in the unclassified location complying with the following table:                  For Canadian Installations apparatus shall be CFM or CSA approved.                  OR                  FM Approved Nonincendive Field Wiring Apparatus installed in the classified location complying with the following table:                  For Canadian Installations apparatus shall be CFM or CSA approved.</p> <table border="1"> <thead> <tr> <th>Voc</th> <th>Maximum current for Groups AB [IIC]</th> <th>Maximum current for Groups CD [IIB, IIA]</th> </tr> </thead> <tbody> <tr> <td>V</td> <td>mA</td> <td>mA</td> </tr> <tr> <td>14</td> <td>274</td> <td>570</td> </tr> <tr> <td>15</td> <td>199</td> <td>531</td> </tr> <tr> <td>16</td> <td>154</td> <td>432</td> </tr> <tr> <td>17.5</td> <td>121</td> <td>360</td> </tr> </tbody> </table>					Voc	Maximum current for Groups AB [IIC]	Maximum current for Groups CD [IIB, IIA]	V	mA	mA	14	274	570	15	199	531	16	154	432	17.5	121	360
Voc	Maximum current for Groups AB [IIC]	Maximum current for Groups CD [IIB, IIA]																				
V	mA	mA																				
14	274	570																				
15	199	531																				
16	154	432																				
17.5	121	360																				
<p>4. To maintain IP66 protection between the BA418CF and the mounting panel:                  Four panel mounting clips should be used                  Minimum panel thickness should be 2mm (0.08inches) Steel                  3mm (0.12inches) Aluminium                  Outside panel finish should be smooth, free from particle inclusions, runs or build-up around cut-out.                  Panel cut-out should be 66.2 x 136.0mm -0.0 +0.5                  (2.60 x 5.35 inches -0.00 +0.02)                  Edges of panel cut-out should be deburred and clean                  Each panel mounting clip should be tightened to between: 20 and 22cNm (1.77 to 1.95 inLb)</p>																						
Cont.																						
Date	Title			Drawn																		
28.03 2006	FM Approvals Control Drawing for Nonincendive BA414DF & BA418CF Fieldbus Indicators			RC																		
Iss.				Checked																		
1																						
				Scale																		
				NTS																		
				Drawing No.																		
				CI410-13																		
				Sheet 2																		

Iss.	Date	Modification	Iss.	Date	Modification	Ckd.	Appd.
						Ckd.	Appd.
Iss.	Date	Modification	Iss.	Date	Modification		
						Ckd.	Appd.
1	28.03 2006	First release					
Title						Drawn RC      Checked      Scale NTS	
FM Approvals Control Drawing for Nonincendive BA414DF & BA418CF Fieldbus Indicators						Drawing No. <b>CI410-13</b> Sheet 3	

5. When installed in a hazardous (classified) location the BA414DF Fieldbus Indicator shall be fitted with cable glands / conduit hubs selected from the following table.

Metallic glands and hubs must be grounded – see note 6.

Class	Permitted gland or conduit hub
Class I	Any metallic or plastic cable gland or conduit hub that provides the required environmental protection.
Class II and III	<p><b>Crouse – Hinds Myler hubs</b> SSTG-1   STG-1   STAG-1 MHUB-1</p> <p><b>O-Z / Gedrey hub</b> CHMG-50DT</p> <p><b>REMKE hub</b> WH-1-G</p> <p><b>Killark Glands</b> CMCXA050   MCR050   MCX050</p>

- In addition to the supplied bonding plate, when 3 metallic glands or conduit hubs are fitted to BA414DF Fieldbus Indicators, all metallic glands or conduit hubs must be connected together and grounded.
- CAUTION:** The BA414DF and BA418CF Fieldbus Indicator enclosures are manufactured from conductive plastic per Article 250 of the National Electrical Code the enclosures shall be grounded using the 'E' terminal on the terminal block.
- The terminator on the Fieldbus must be FM Approved or for Canadian Installations CFM or CSA Approved
- The BA414DF and the BA418CF should be mounted where they are shielded from direct sunlight.

Cont.



Iss.	1	Date	28.03 2006	Modification	First release	Ckd.	.	Appd.	.	
Iss.		Date		Modification		Ckd.		Appd.		
 <b>associates</b> England company confidential, copyright reserved.										
<p style="text-align: center;"><b><u>FNICO Rules</u></b></p> <p>The FNICO Concept allows the interconnection of intrinsically safe apparatus to associated apparatus not specifically examined in such combination. The criterion for such interconnection is that the voltage (Vmax), the current (Imax) and the power (Pmax) which intrinsically safe apparatus can receive and remain intrinsically safe, considering faults, must be equal or greater than the voltage (Uo, Voc or Vt), the current (Io, Isc or It) and the power (Po) which can be provided by the associated apparatus (supply unit). In addition the maximum unprotected residual capacitance (Ci) and inductance (Li) of each apparatus (other than terminators) connected to the Fieldbus must be less than or equal to 5nF and 20uH respectively.</p> <p>In each I.S. Fieldbus segment only one active source, normally the associated apparatus, is allowed to provide the necessary power for the Fieldbus system. The allowed voltage (Uo, Voc or Vt) of the associated apparatus used to supply the bus cable must be limited to the range 14Vdc to 17.5Vdc. All other equipment connected to the bus cable has to be passive, meaning that the apparatus is not allowed to provide energy to the system, except a leakage current of 50µA for each connected device. Separately powered equipment needs galvanic isolation to ensure the intrinsically safety Fieldbus circuit remains passive.</p> <p>The cable used to interconnect the devices needs to comply with the following parameters:                  Loop resistance R': 15....150Ω/km                  Inductance per unit length L':0.4....1mH/km</p> <p>Capacitance per unit length C': 80....200nF/km                  C' = C' line/line+0.5 C' line/screen, if both lines are floating                  or                  C' = C' line/line + C'line/screen, if the screen is connected to one line.                  Length of spur cable: max. 30m                  Length of trunk cable: max. 1km                  Length of splice: max = 1m</p> <p>Terminators                  At the end of each trunk cable an FM Approved line terminator with the following parameters is suitable:                  R= 90...100Ω                  C = 0....2.2µF</p> <p>System evaluation                  The number of passive devices like transmitters, actuators, connected to a single bus segment is not limited due to nonincendive reasons. Furthermore, if the above rules are respected, the inductance and the capacitance of the cable need not be considered and will not impair the intrinsic safety of the installation.</p> <p>Notes.                  1. The FNICO concept allows the interconnection of FM Approved nonincendive devices with FNICO parameters not specifically examined in combination as a system when:                  Uo or Voc or Vt ≤ Vmax.</p> <p style="text-align: center;">For Canadian installations the FNICO concept allows the interconnection of CFM or CSA Approved nonincendive devices with FNICO parameters not specifically examined in combination as a system when:                  Uo or Voc or Vt ≤ Vmax.</p>										
Title				Drawn RC			Checked		Scale NTS	
FM Approvals Control Drawing for Nonincendive BA414DF & BA418CF Fieldbus Indicators				Drawing No. Sheet 4		CI410-13				

## APPENDIX 2 IECEX Certification

### A2.0 The IECEx Certification Scheme

IECEX is a global certification scheme for explosion protected products which aims to harmonise international certification standards.

For additional information about the IECEx certification scheme and to view the BEKA associate certificates, please visit [www.iecex.com](http://www.iecex.com)

### A2.1 IECEx Certificate of Conformity

The BA418CF-F Fieldbus Indicator has been issued with an IECEx Certificate of Conformity number IECEx ITS 06.0013X which specifies the following certification codes and marking:

Ex ia IIC T4 Ga  
FISCO Field Device Ex ia IIC T4  
Ta = -40°C to 70°C

See below for details of safe use in Zone 0.

### CAUTION

#### Installation in Zone 0

**When installed in a Zone 0 potentially explosive atmosphere, the indicator shall be installed such that even in the event of rare incidents, an ignition source due to impact or friction between the aluminium enclosure at the rear of the instrument mounting panel and iron/steel is excluded.**

When connected to an IECEx certified system the BA418CF-F may be installed in:

- Zone 0 explosive gas air mixture continuously present. **Note:** Special conditions for safe use apply see above.
- Zone 1 explosive gas air mixture likely to occur in normal operation.
- Zone 2 explosive gas air mixture not likely to occur, and if it does will only exist for a short time.

Be used with gases in groups:

- Group A propane
- Group B ethylene
- Group C hydrogen

Having a temperature classification of:

- T1 450°C
- T2 300°C
- T3 200°C
- T4 135°C

At an ambient temperature between -40 and +70°C.

**Note:** the guaranteed operating temperature range of the BA418C Fieldbus Indicator is -20 to +70°C

The IECEx safety parameters are identical to the ATEX parameters and, like the ATEX certification, confirm that the BA418CF-F complies with the FISCO Field Device requirements specified in IEC60079-27.

The IECEx certificate may be downloaded from [www.beka.co.uk](http://www.beka.co.uk), [www.iecex.com](http://www.iecex.com) or requested from the BEKA sales office.

### A2.2 Installation

The BA418CF-F IECEx and ATEX certifications have identical intrinsic safety parameters and installation requirements. The ATEX system design requirements described in section 3 of this manual may therefore be used for IECEx installations, but the local code of practice should always be consulted.